

PLAN

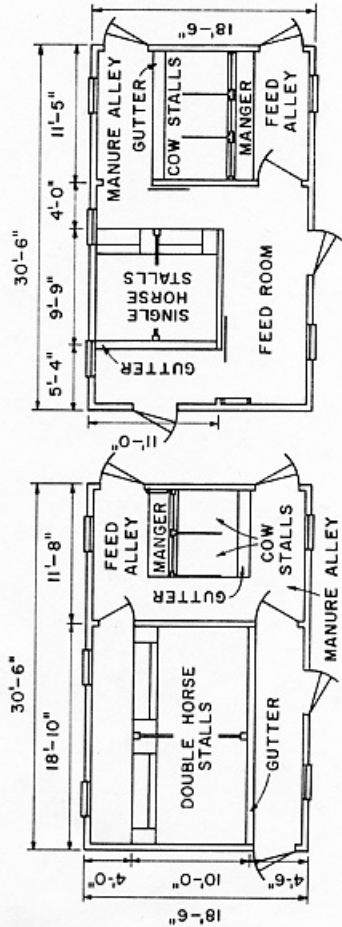

ALTERNATE PLANS
SCALE: 1/8"=1'-0"

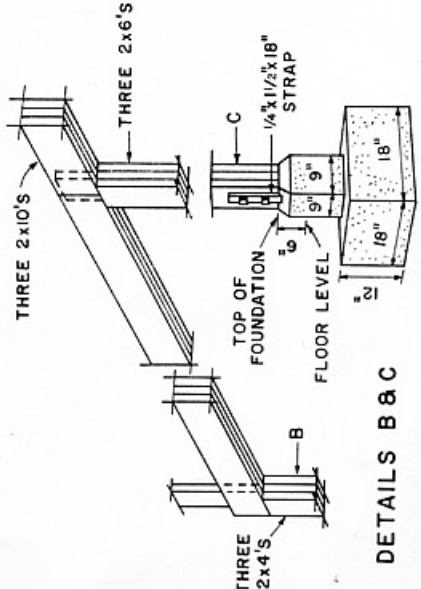
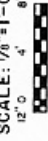

DETAILS B & C

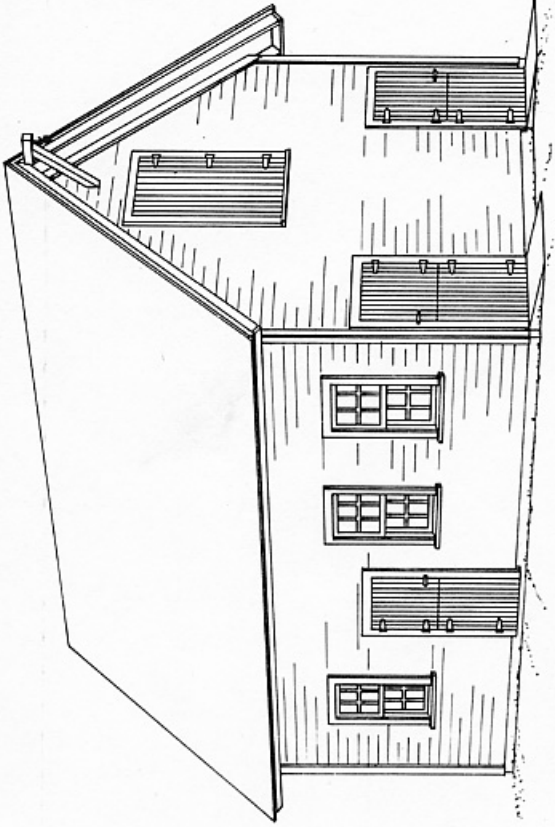

PERSPECTIVE

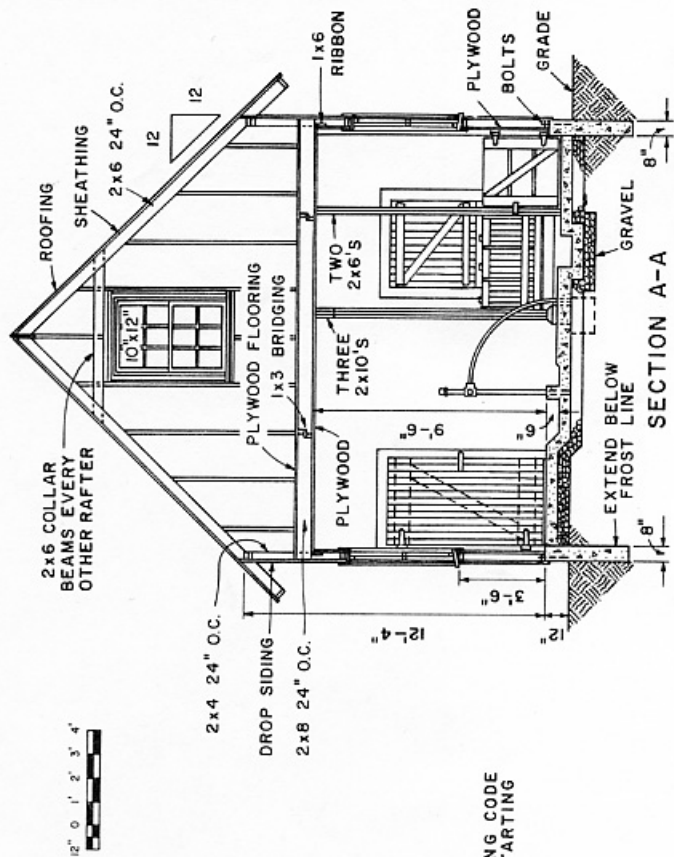

SECTION A-A

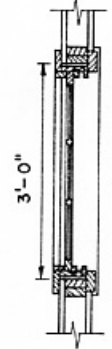

SECTION OF WINDOW

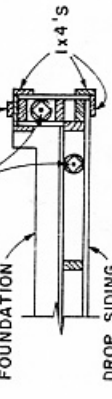

SECTION AT CORNER

NOTE: CONSULT LOCAL BUILDING CODE AUTHORITIES BEFORE STARTING CONSTRUCTION.

COOPERATIVE EXTENSION WORK IN AGRICULTURE AND HOME ECONOMICS
STATE OF TENNESSEE
UNIVERSITY OF TENNESSEE
AGRICULTURAL ENGINEERING DEPARTMENT
UNITED STATES DEPARTMENT OF AGRICULTURE COOPERATING

GENERAL BARN

USDA '76 6 2 6 7 SHEET 1 OF 1

BASED ON: USDA PLAN NO. 5021